

Three piece Ball Valve

Technical Guide W4.13

Three piece 316 stainless steel Ball Valve



1.1.22 | W4.13 FULL BORE BALL VALVE LEVER OPERATED

Applications

Chemical service

Water treatment

Waste water treatment

Product Attributes

Lockable handle

Three piece construction

All 316SS or CF8M

Blow out proof stem

Quality

ISO 9001:2008 Quality

Management Standard

We are the supply partner of choice for New Zealand's civil construction industry, specialising in water and infrastructure based solutions.

HYNDSwater

Features

- 316 stainless steel body, cap & ball
- Full bore
- Threaded BSP
- Quality investment cast body and cap
- Internal entry blow-out proof stem
- Lever handle with locking device

Technical Information

- Type: V3-316-PP (V3E) series
- Size: ¼" to 4"
- Pressure (@20°C): 1000PSI WOG
- Pressure Test: API 598



FIG. 1

TABLE 1

NO.	DESCRIPTION	MATERIAL
1	Body	CF8M
2	Cap	CF8M
3	Ball	CF8M
4	Ball Seat	PTFE
5	Joint Gasket	PTFE
6	Stem	SS316
7	Thrust Washer	PTFE
8	Stem Packing	PTFE
9	Gland Nut	SS304
10	Handle	SS304
11	Stem Washer	SS304
12	Stem Nut	SS304
13	Handle Sleeve	Plastic
14	Locking Device	SS304
15	Bolt	SS304
16	Spring Washer	SS304
17	Hex Nut	SS304

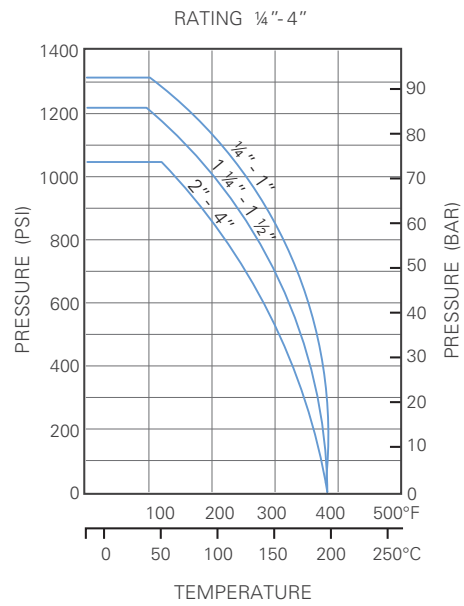

TABLE 3

TABLE 2

DN	NPS	FxF	Ød	h1	l1	l	CV Factor	Torque (N.m)	Weight (Kg)	Ød1	Ød2	Ød3	Ød4
8	¼"	58	11.6	54	102	13	6	6	0.33	17	14.1	17	10
10	⅜"	58	12.7	54	102	13	7	8	0.32	17	17.6	17	12.5
15	½"	63	15	62	123	13.5	10	11	0.47	21.3	21.7	21.3	16
20	¾"	73	20	66	123	16	25	14	0.60	26.7	27.1	26.7	20
25	1"	85	25	77	153	17	35	18	0.86	33.6	33.8	33.6	25
32	1 ¼"	96	32	80	153	19.1	46	28	1.34	42.4	42.6	42.4	33.8
40	1 ½"	114	38	91	183	19.1	80	45	1.96	48	48.7	48	39.5
50	2"	134	50	98	183	23.5	110	52	3.06	60.5	61.1	60.5	50.8
65	2 ½"	180	65	144	246	32	310	67	6.41	76.1	76.9	76.1	62.7
80	3"	200	80	155	246	39	360	95	9.10	88.9	89.8	88.9	77.9
100	4"	228	100	161	350	33	820	125	14.33	114.2	115.5	114.2	100

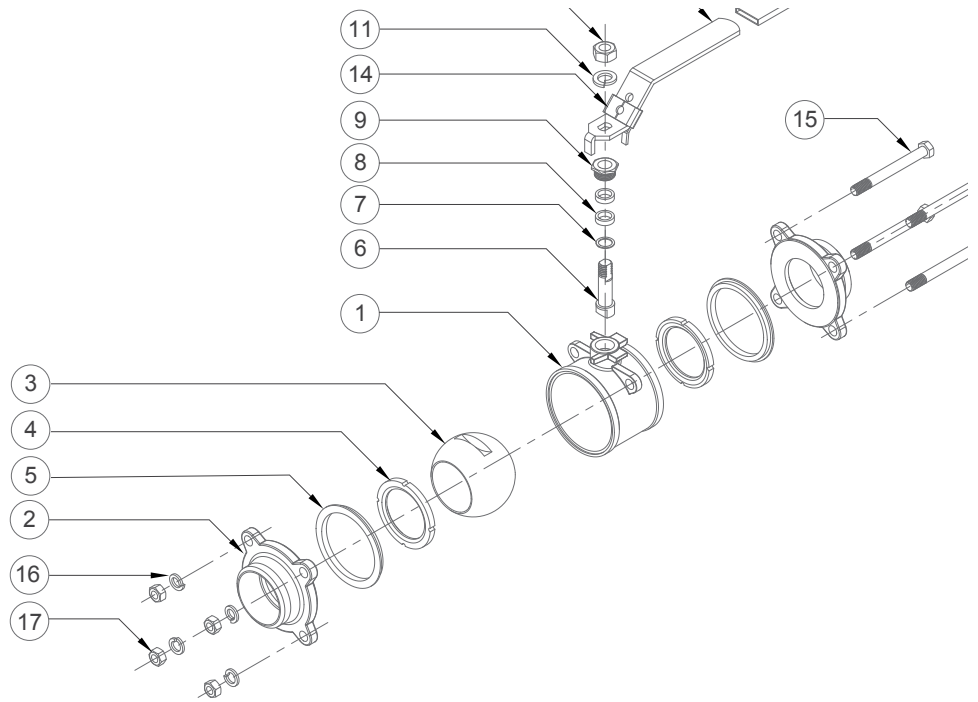

FIG. 2

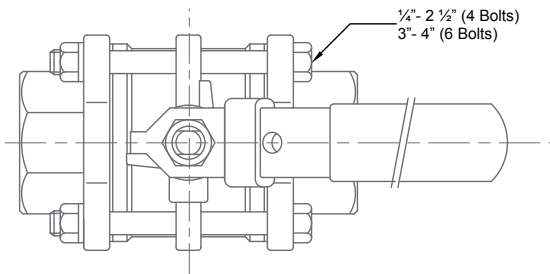

FIG. 3

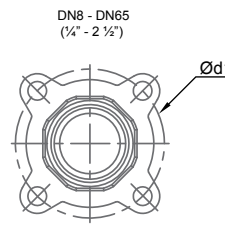

FIG. 4

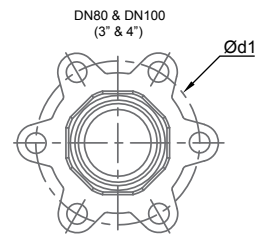

FIG. 5

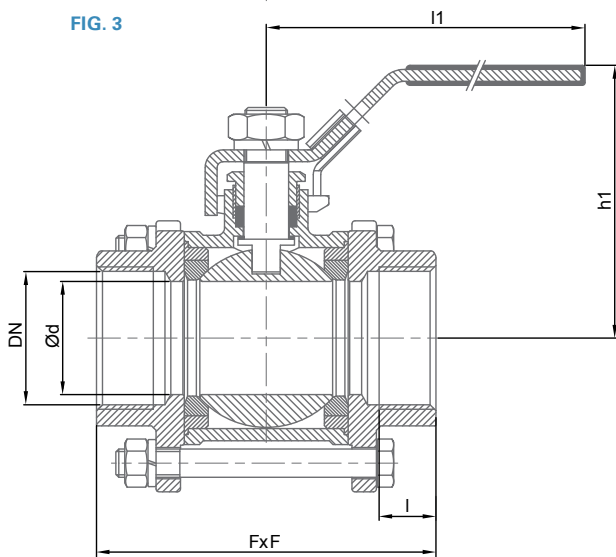

FIG. 6

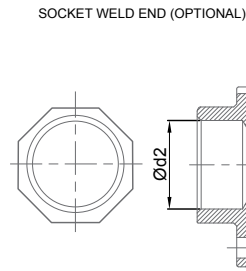

FIG. 7

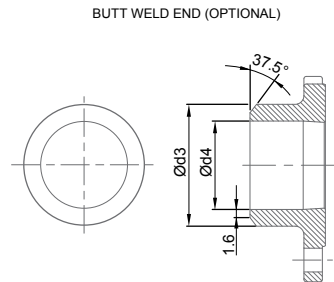

FIG. 8

Branches Nationwide *Support Office & Technical Services 0800 93 7473*

Disclaimer: While every effort has been made to ensure that the information in this document is correct and accurate, users of Hynds product or information within this document must make their own assessment of suitability for their particular application. Product dimensions are nominal only, and should be verified if critical to a particular installation. No warranty is either expressed, implied, or statutory made by Hynds unless expressly stated in any sale and purchase agreement entered into between Hynds and the user.